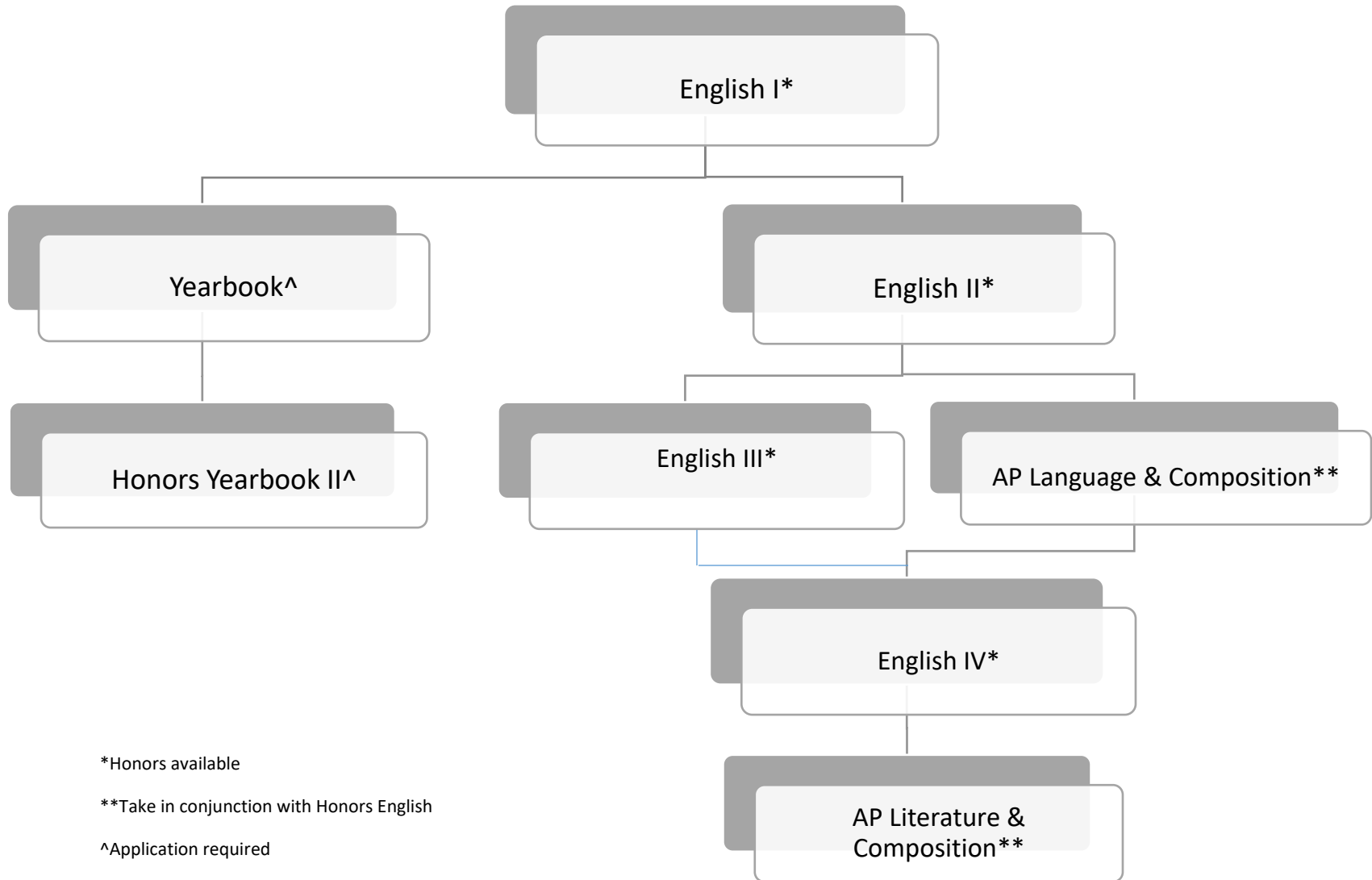

TABLE OF CONTENTS

ENGLISH.....	2
MATHEMATICS	3
SCIENCE	4
SOCIAL STUDIES	5
FOREIGN LANGUAGE.....	6
VISUAL ARTS.....	7
BAND.....	8
ORCHESTRA	9
CHORUS.....	10
THEATRE ARTS	11
BUSINESS & MARKETING.....	12
CULINARY ARTS.....	13
EARLY CHILDHOOD EDUCATION	14
HEALTH SCIENCE	15
GAMING TECHNOLOGY & 3D DESIGN	16
CARPENTRY.....	17
DRAFTING & ENGINEERING	18, 19
JROTC	20
PHYSICAL EDUCATION.....	21

ENGLISH



MATHEMATICS

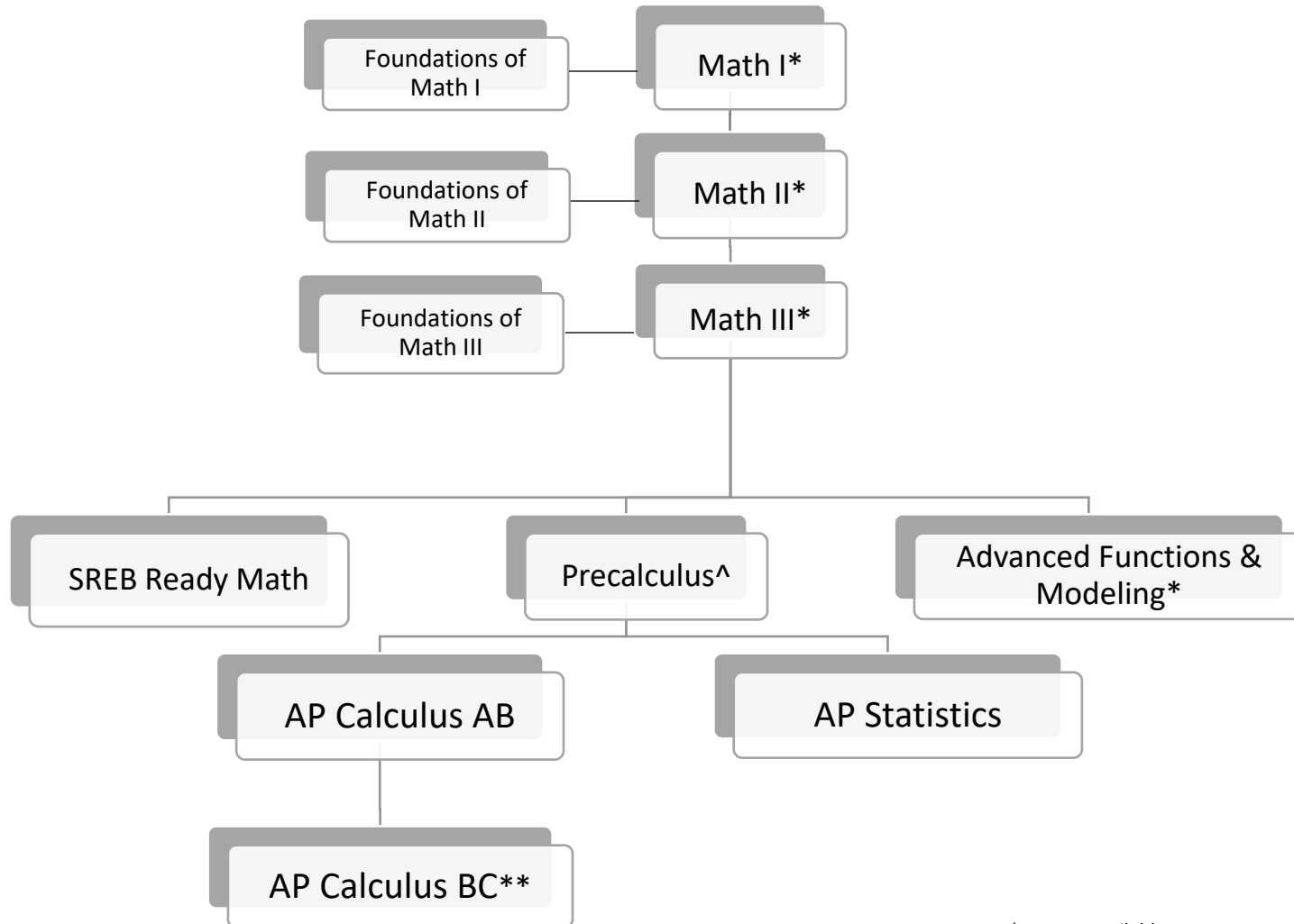

*Honors available

^Automatically Honors

**Taken in conjunction with Calculus AB

SCIENCE

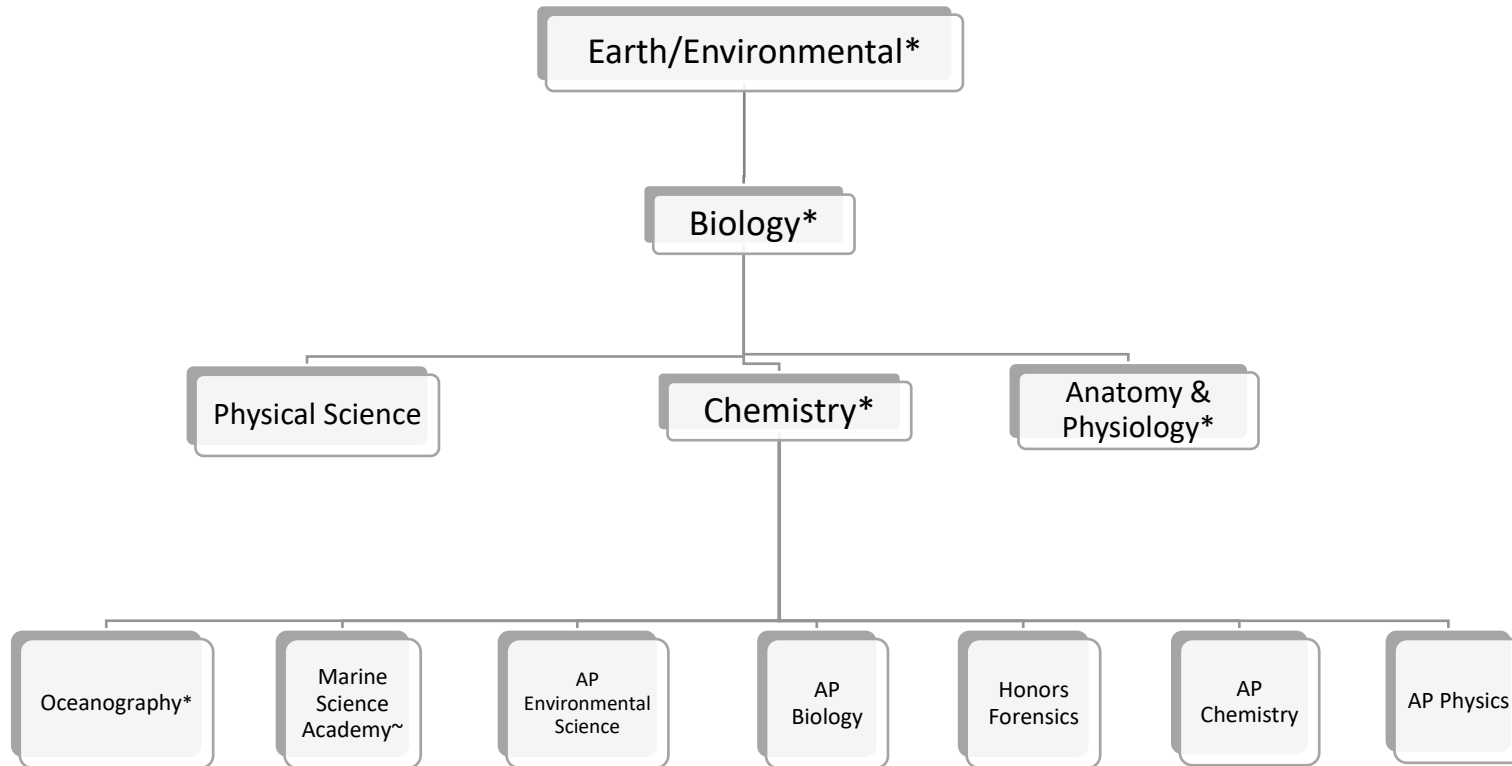

*Honors available

~Application required

SOCIAL STUDIES

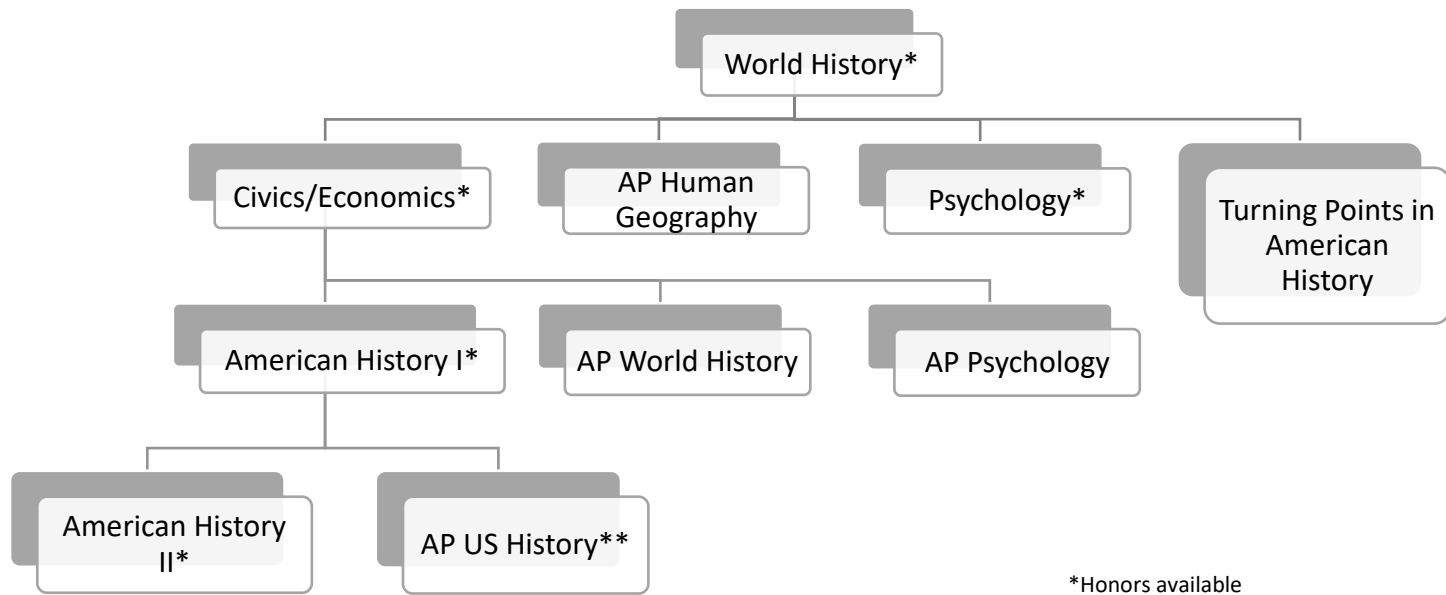

*Honors available

**Take in conjunction with Honors American History I

FOREIGN LANGUAGE

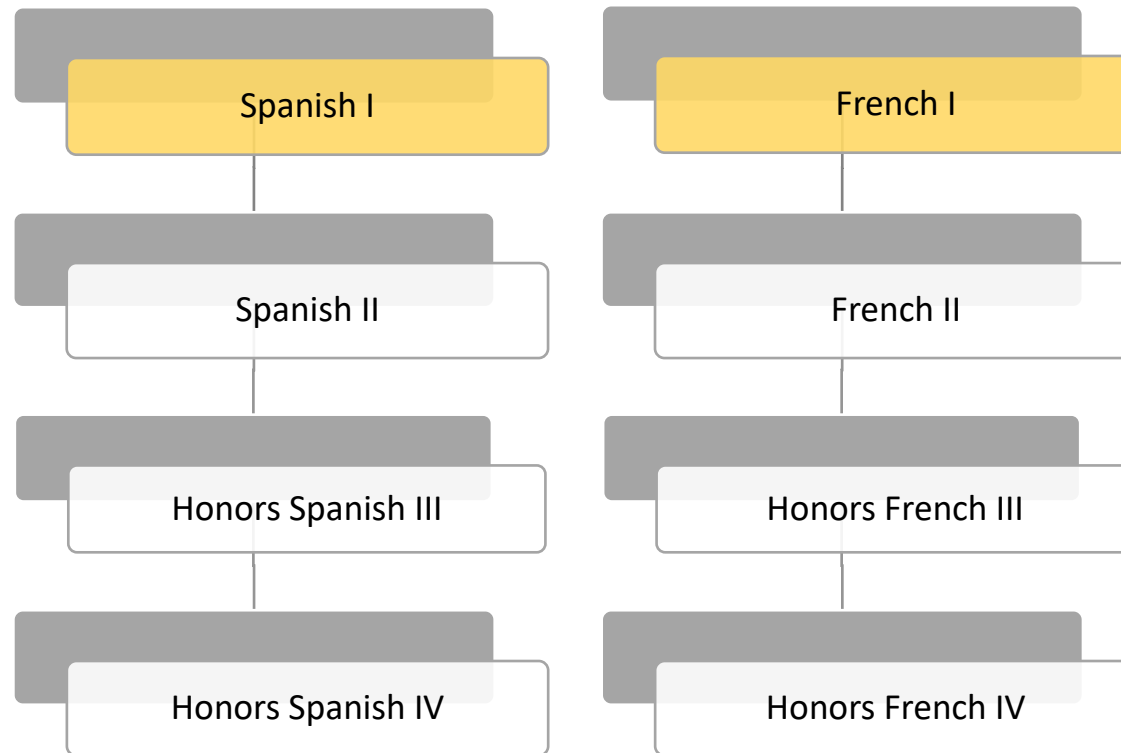

Other foreign languages are offered online through NCVPS; we recommend students complete at least one other online course successfully before attempting a foreign language online.

VISUAL ARTS

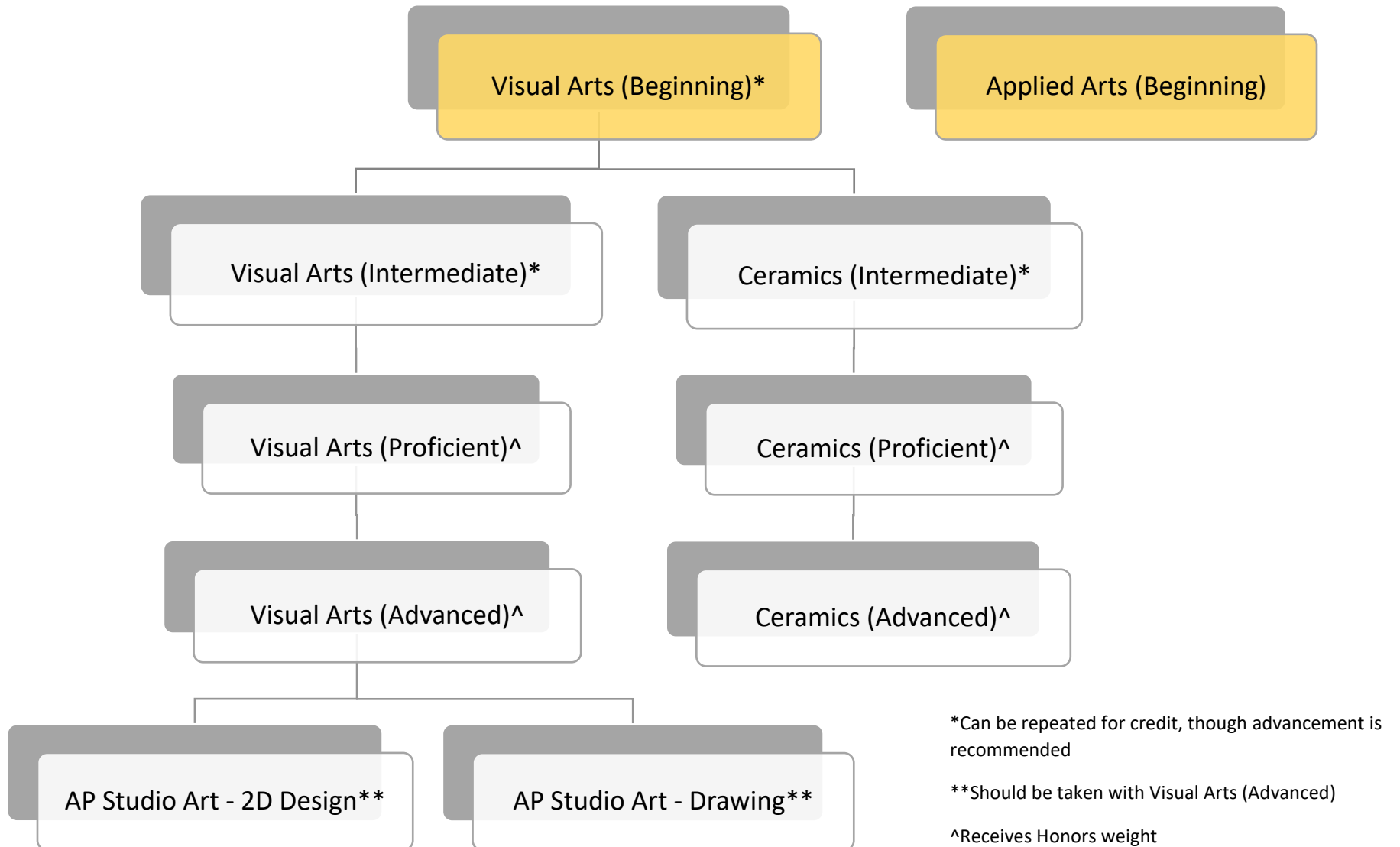

BAND

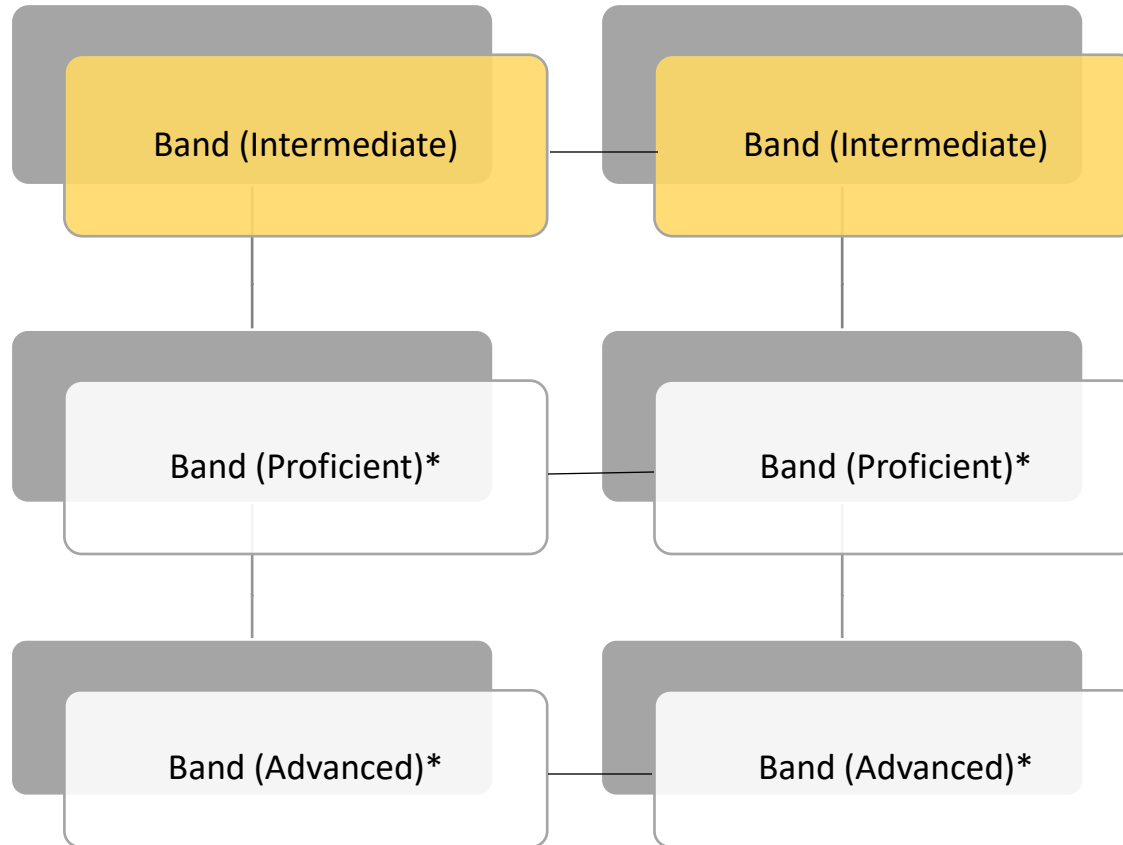

*Automatically Honors; advancement based on instructor evaluation

ORCHESTRA

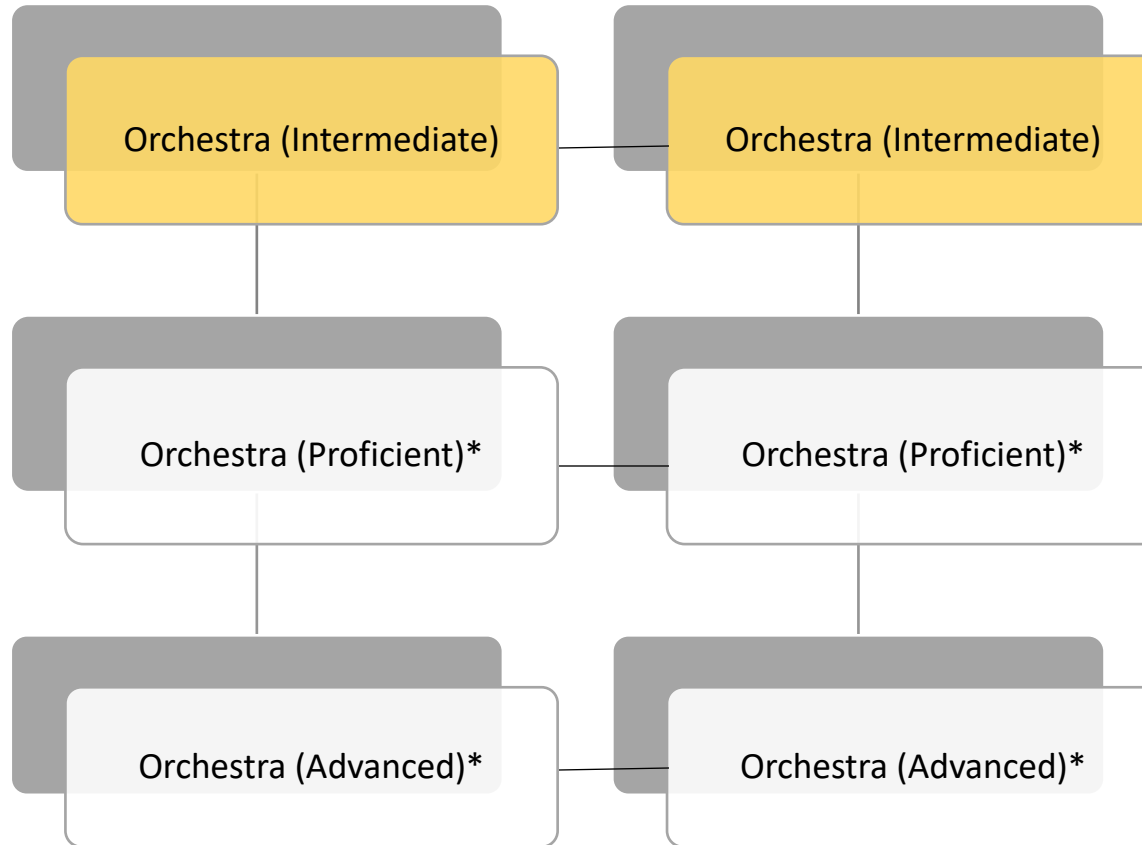

*Automatically Honors; advancement based on instructor evaluation

CHORUS

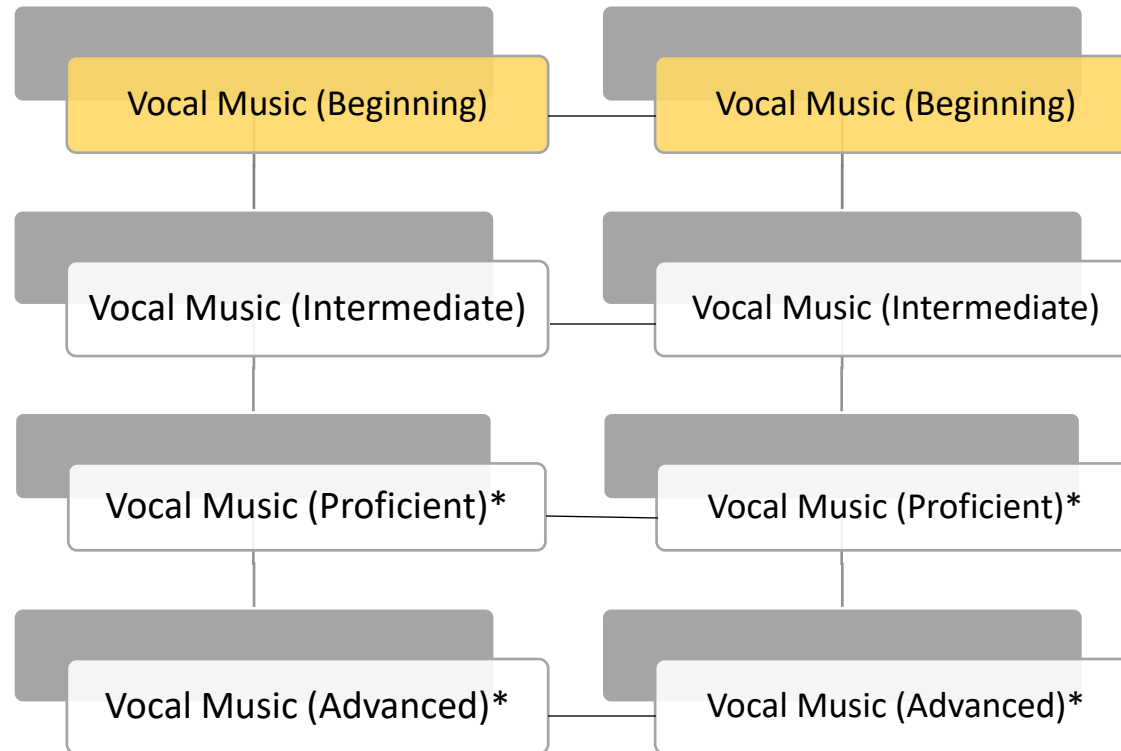

*Automatically Honors; advancement based on instructor evaluation

THEATRE ARTS

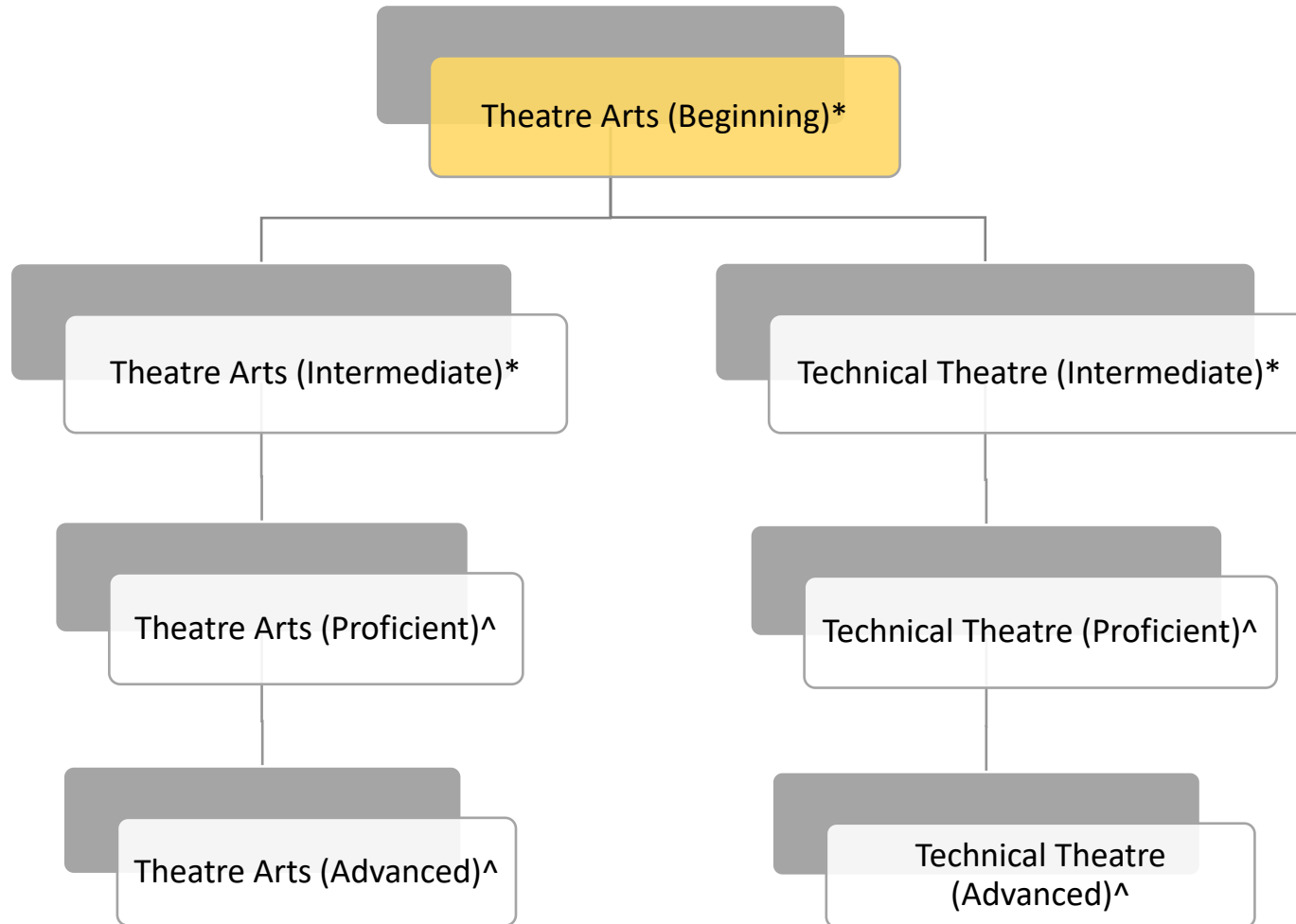

* Can be repeated for credit, though advancement is recommended

^ Receives Honors weight

BUSINESS & MARKETING

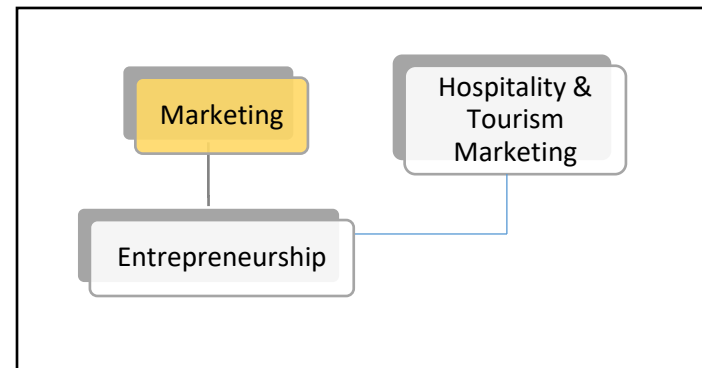
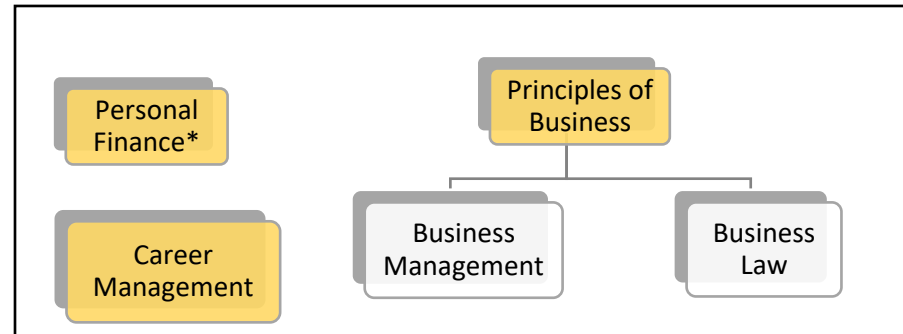
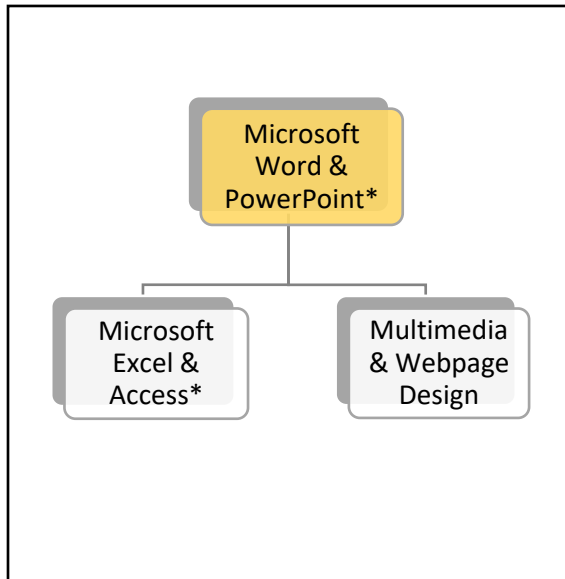

*Honors available

CULINARY ARTS

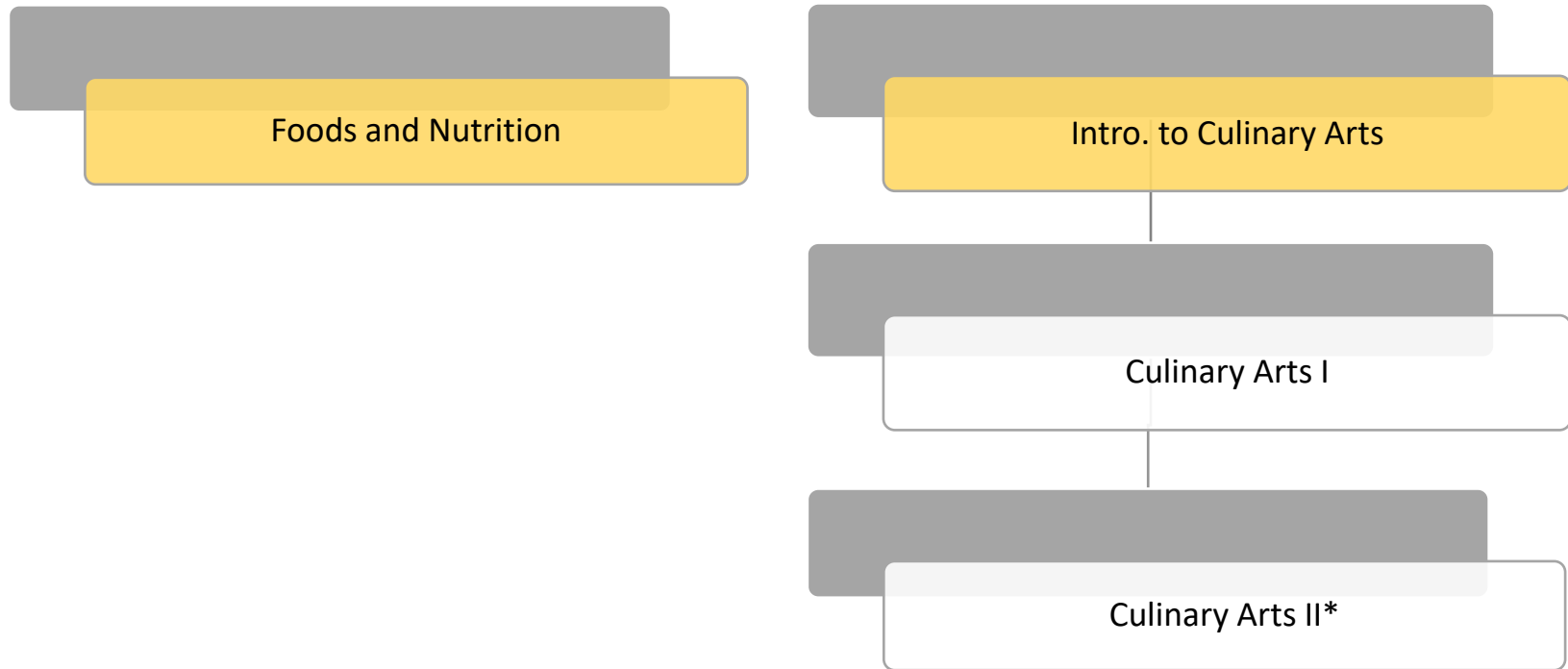

*Two-credit course and receives Honors weight

EARLY CHILDHOOD EDUCATION

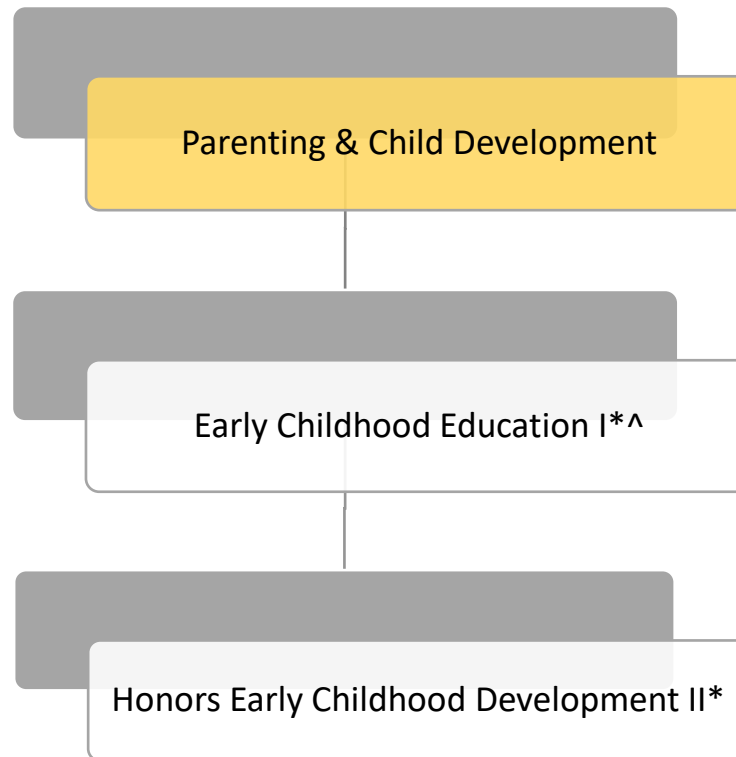

*Two-credit course

^Must be 16 years of age by December 15th of that year to enroll

HEALTH SCIENCE

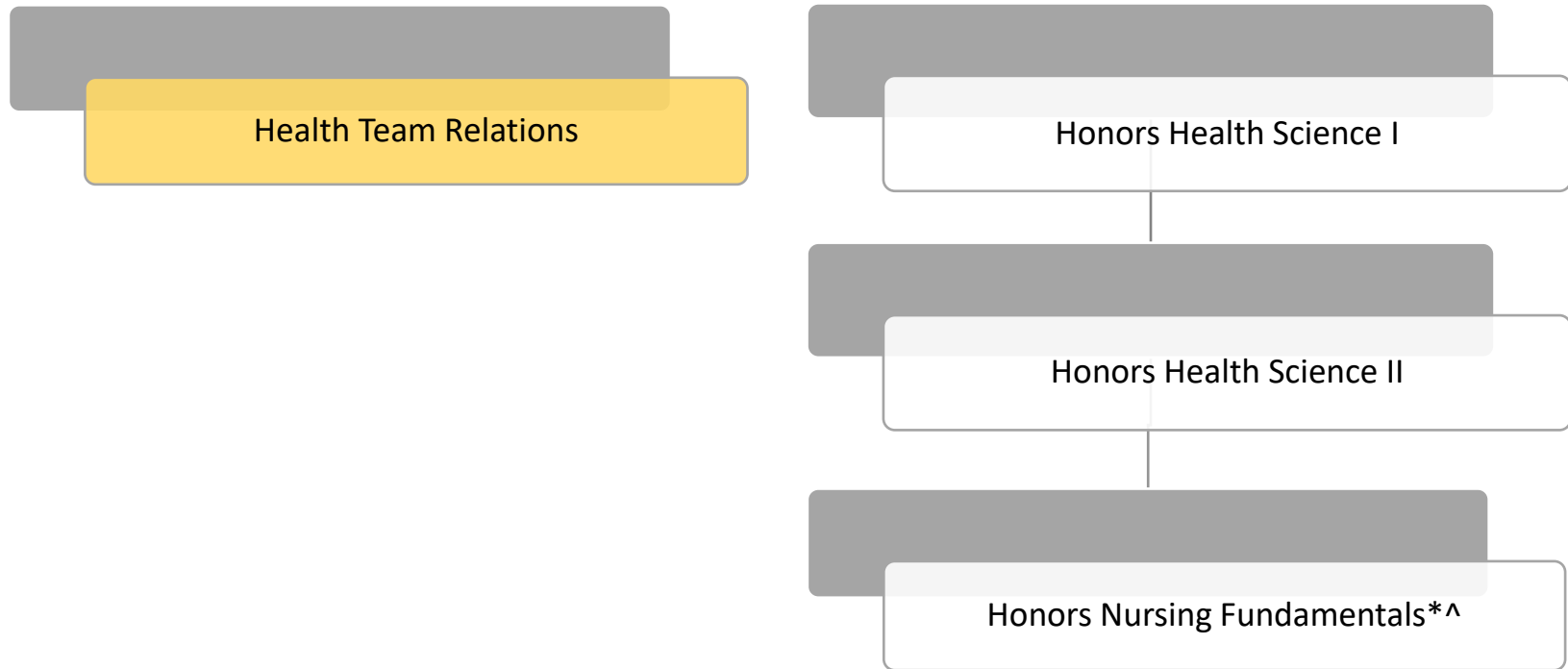

*Two-credit course

^Application required

GAMING TECHNOLOGY & 3D DESIGN

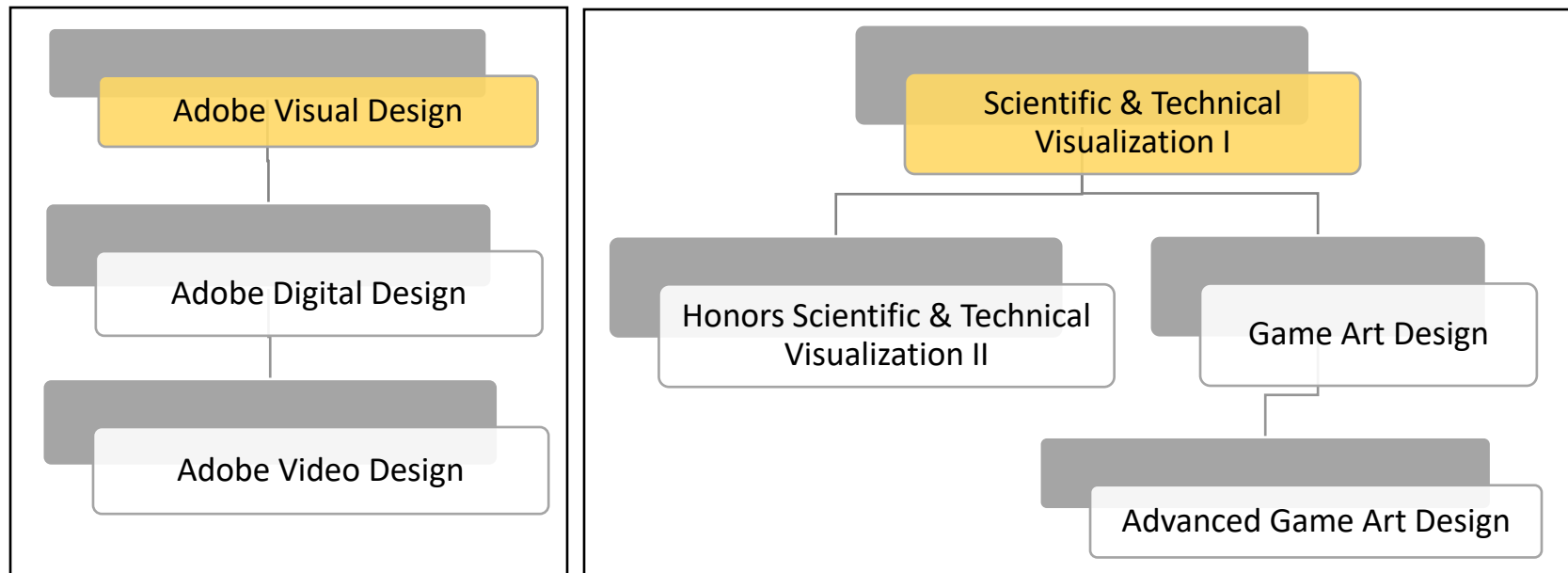

CARPENTRY

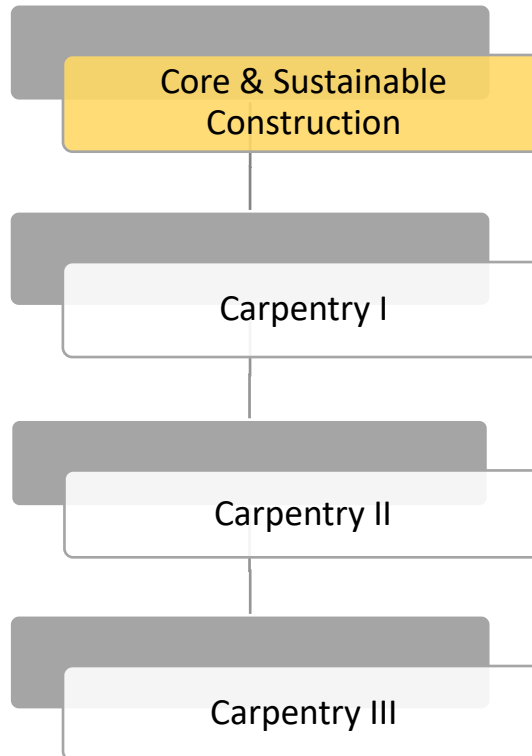

DRAFTING & ENGINEERING

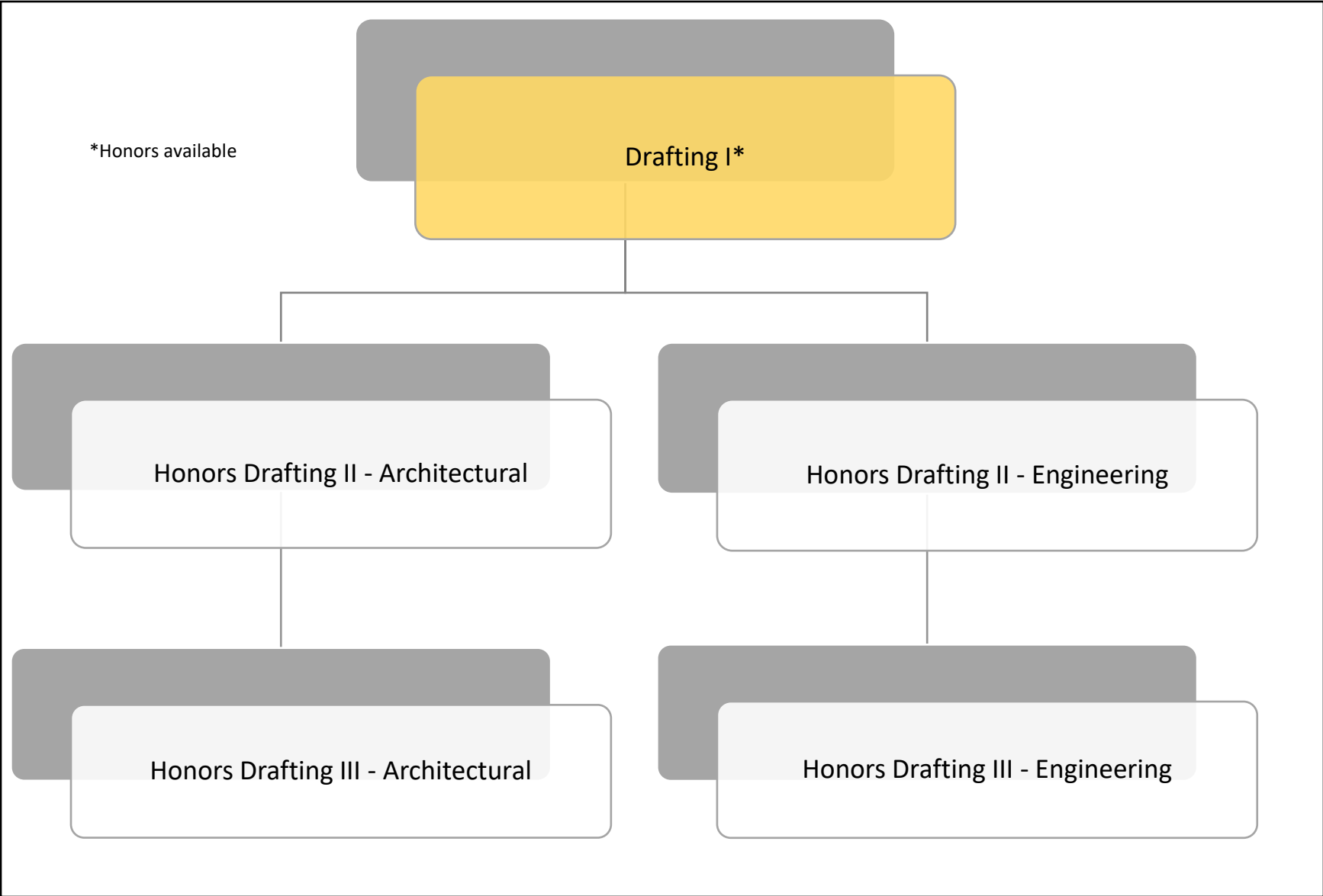

DRAFTING & ENGINEERING (cont.)

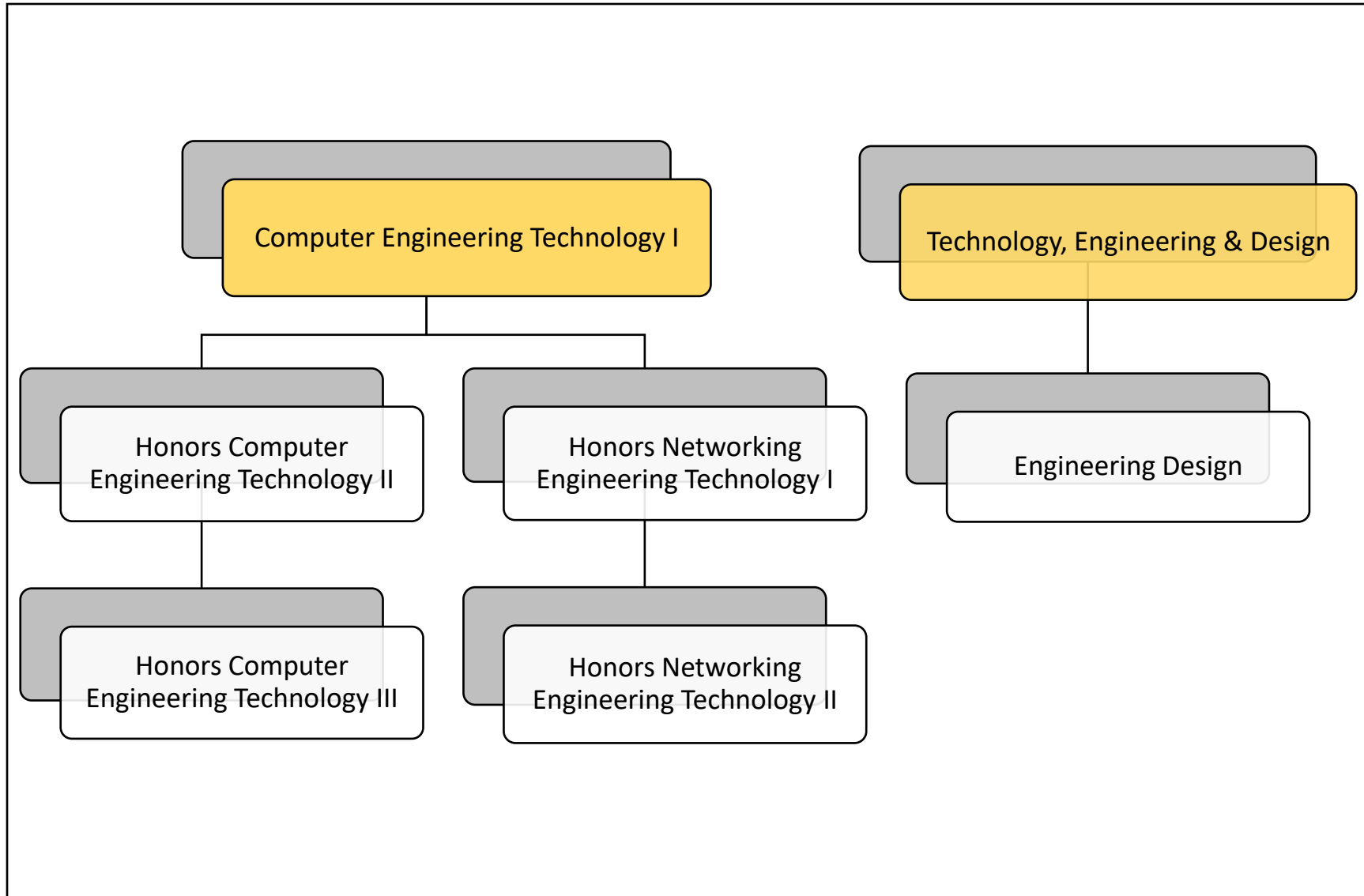

JROTC

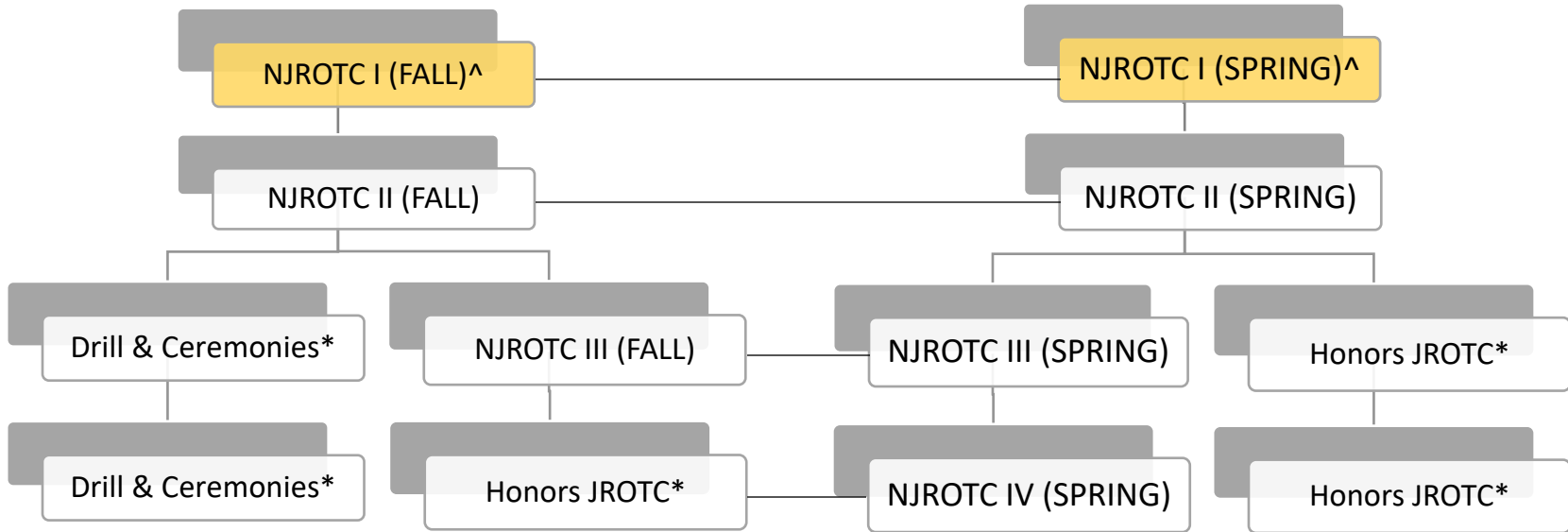

^Application required

*Instructor approval required

PHYSICAL EDUCATION

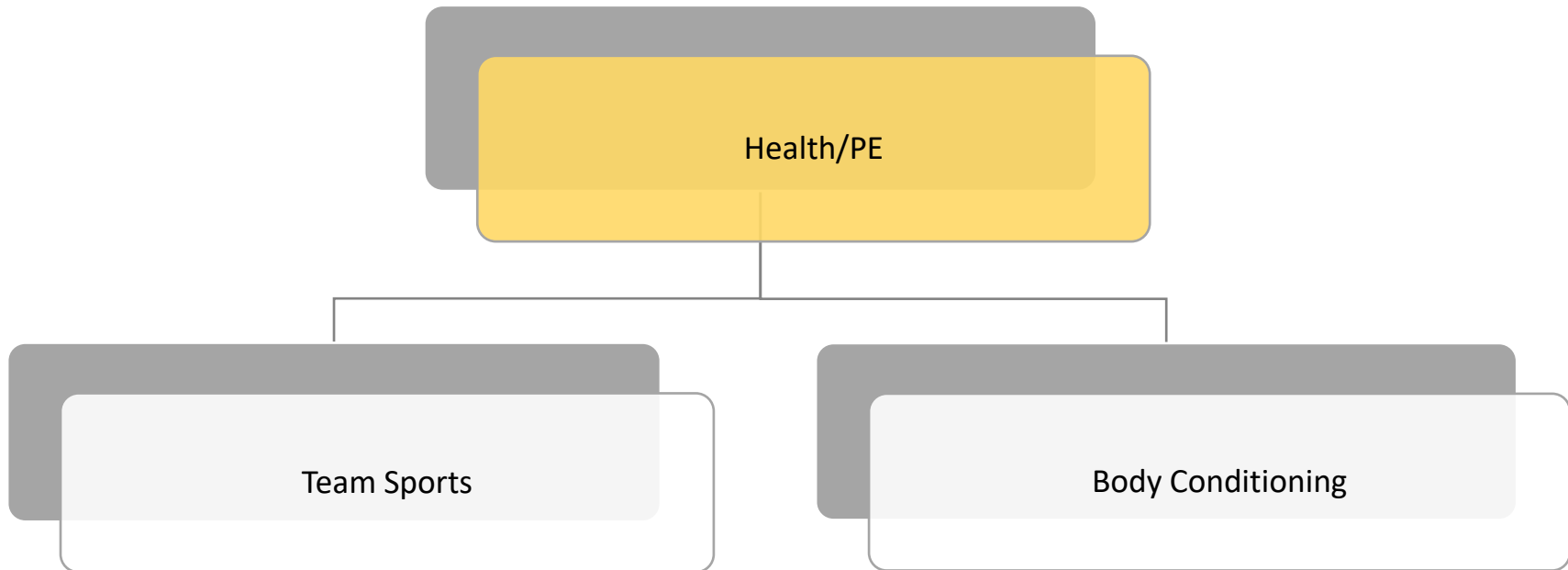

INDEX

BAND.....	8
BUSINESS & MARKETING	12
CARPENTRY	17
CHORUS.....	10
CULINARY ARTS	13
DRAFTING & ENGINEERING	18, 19
EARLY CHILDHOOD EDUCATION	14
ENGLISH	2
FOREIGN LANGUAGE	6
GAMING TECHNOLOGY & 3D DESIGN	16
HEALTH SCIENCE	15
JROTC	20
MATHEMATICS	3
ORCHESTRA	9
PHYSICAL EDUCATION.....	21
SCIENCE	4
SOCIAL STUDIES	5
THEATRE ARTS	11
VISUAL ARTS.....	7